

MODELLO / MODEL
VER090FM

INFORMAZIONI TECNICHE / TECHNICAL INFORMATION

Massa base unità (corsa zero) <i>Unit's base mass (zero stroke)</i>	[Kg]	8,9
Massa lineare unità <i>Unit's linear mass</i>	[Kg/100mm]	1,29
Massa carro <i>Carriage's mass</i>	[Kg]	4,9
Velocità massima* <i>Maximum velocity</i>	[m/s]	4
Ripetibilità a vuoto <i>Unloaded repeatability</i>	[mm]	0,1
Sviluppo puleggia <i>Pulley's circumference</i>	[mm/giro]	220
Taglia cinghia <i>Belt's size</i>	[-]	50 AT 10
Forza massima di trazione sulla cinghia* <i>Maximum traction force on belt</i>	[N]	2892
Momento principale d'inerzia Y <i>Principal moment of inertia Y</i>	[cm ⁴]	203
Momento principale d'inerzia Z <i>Principal moment of inertia Z</i>	[cm ⁴]	278

* I valori sono da considerarsi indicativi.
Prestazioni superiori sono possibili e vanno verificate col nostro ufficio tecnico.
*Values should be considered as an indication.
Higher performance are possible. Please contact our technical department.*

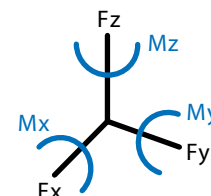
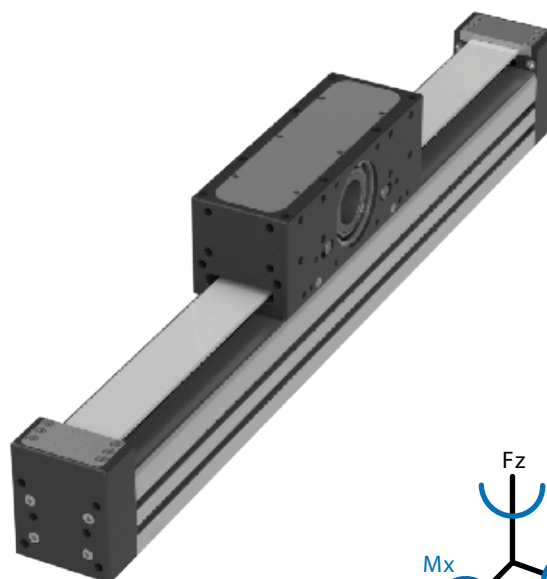

CARICO MASSIMO AMMISSIBILE / MAXIMUM PERMISSIBLE LOAD

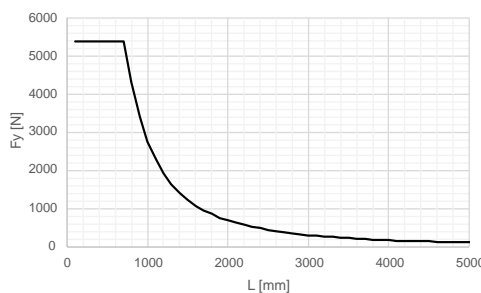
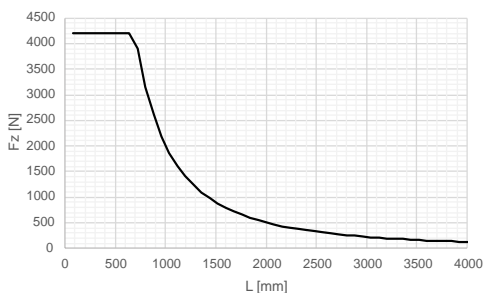

Sono rappresentati i carichi massimi applicabili in condizioni isostatiche, in appoggio, con vincolo torsionale semplice e carico in mezzzeria.
Maximum load in isostatic condition centrally loaded.

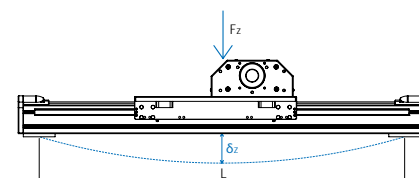

CARICO MASSIMO AMMISSIBILE / MAXIMUM PERMISSIBLE LOAD

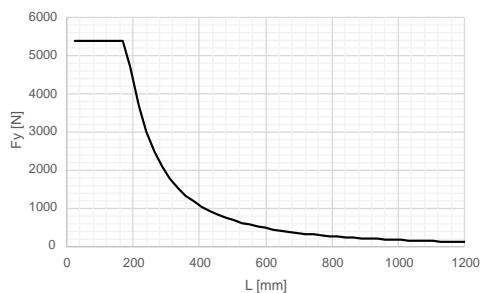
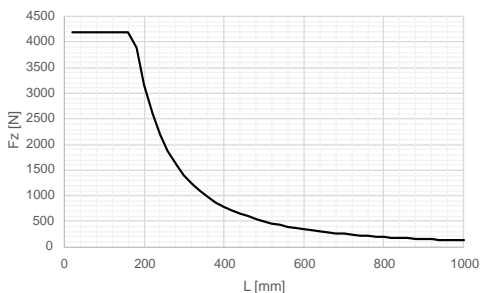

Sono rappresentati i carichi massimi applicabili in condizioni isostatiche, con vincolo rigido e carico all'estremità.
Maximum load in an isostatic cantilever loaded condition.

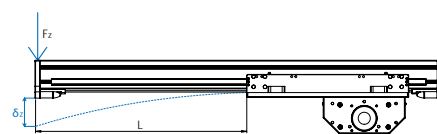

Si raccomanda di non superare i limiti dei grafici per non avere malfunzionamento dell'unità, peggioramento delle prestazioni o eccessiva usura.
We recommend not to exceed the maximum values to avoid lower performance, a reduced reliability and a big wear of the components.

DIMENSIONI / DIMENSIONS

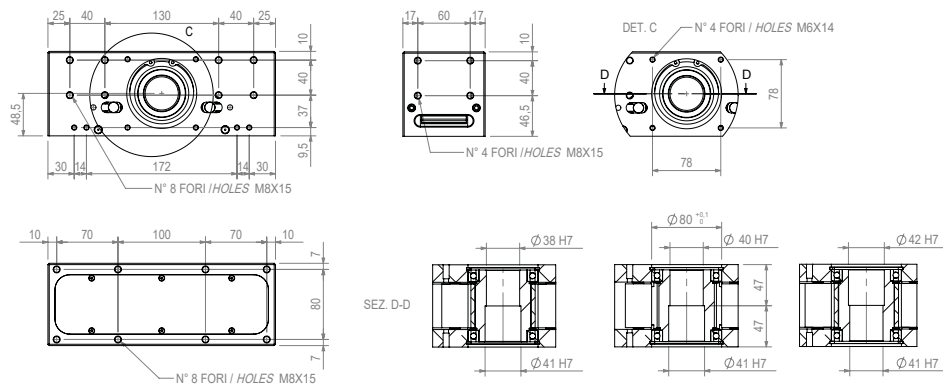
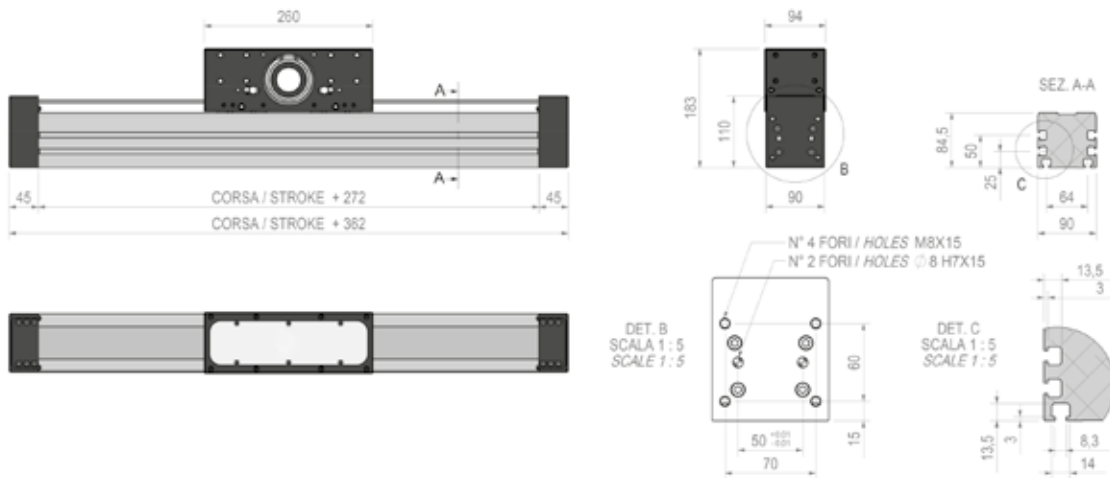

Tipologia interfaccia riduttore ②
Gearbox interface type
Kit IF30

Configurazioni puleggia
Pulley configurations

Accessori Accessories	Cinghia Belt	Vite Ball screw	Crema-gliera Rack and pinion
① Riduttore Gearbox	x	x	x
② Kit assiale Axial kit	x	x	x
③ Calettatore Keyless Locking Device	x		x
④ Albero di torsione Torsion shaft	x		x
⑤ Carro aggiuntivo Additional carriage	x		x
⑥ Giunto elastico Elastic coupling	x		
⑦ Freno stazionamento Standing brake	x		
⑧ Elemento fissaggio/tassello Fastening/plug	x	x	x
⑨ Kit rinvio Transfer box	x	x	
⑩ Supporto sensore/Camma Sensor bracket/Camma	x	x	x

Le Unità Damo sono disponibili con una vasta gamma di accessori e optional specifici concepiti per facilitare la realizzazione e installazione di sistemi monoasse e multiasse.

All Units are available with a wide range of accessories and specific options designed to simplify the construction and installation of single-axis and multi-axis systems.

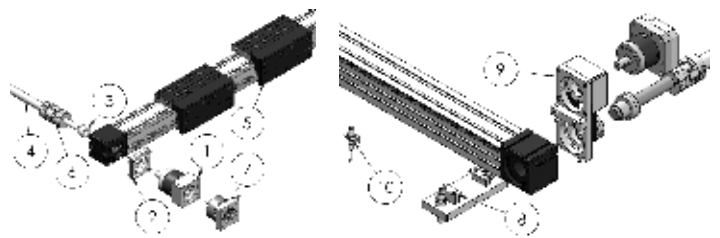

L'ufficio tecnico è a disposizione per la valutazione di applicazioni speciali e per analisi approfondite.
The technical department is available for the evaluation of special applications and for detailed analysis.

MODELLO / MODEL
VER090FM

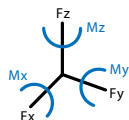

Sono rappresentate le deformazioni massime in condizioni isostatiche, in appoggio, con vincolo torsionale semplice e carico in mezzzeria. La deformazione effettiva dipende dalle condizioni di vincolo e dalla combinazione di carico.

Maximum deflection in isostatic condition centrally loaded. Actual strain depends on constraint condition and load combination.

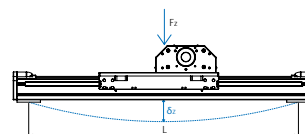

DEFORMAZIONE ELASTICA / ELASTIC DEFORMATION

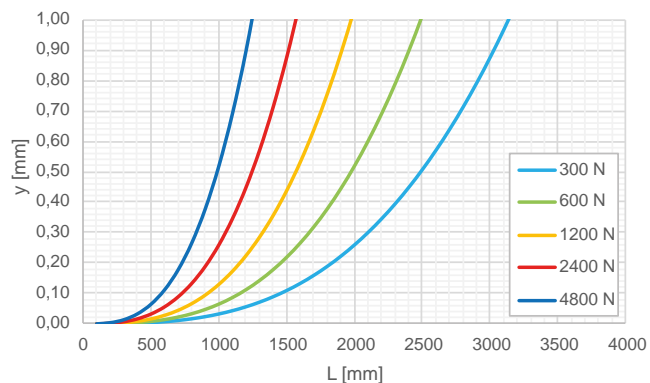
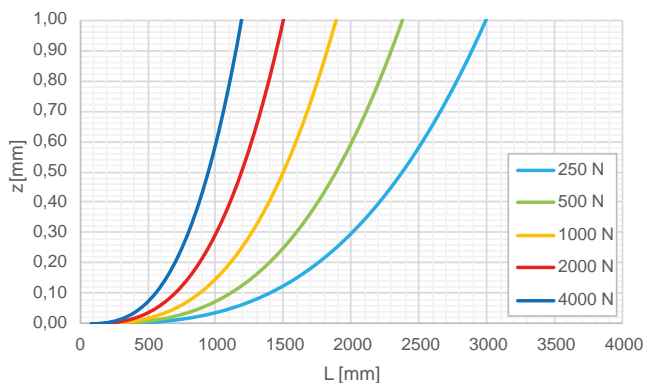

LIMITI STRUTTURALI / STRUCTURAL LIMITS

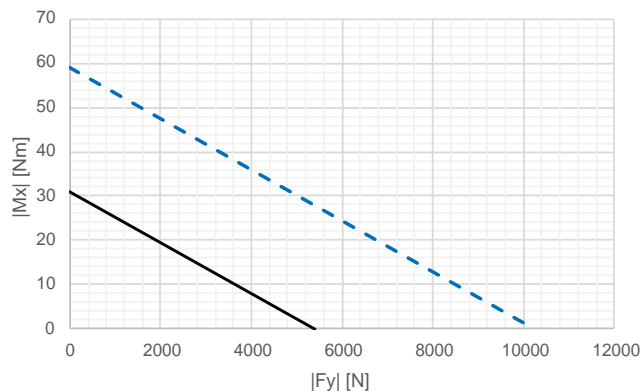
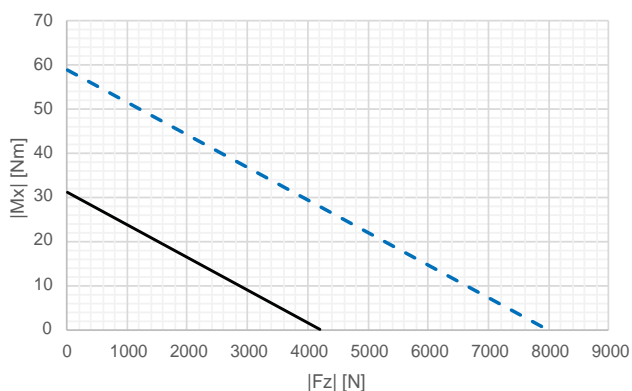

— Limite rottura a fatica: vita stimata superiore ai 10×10^6 cicli col 99% probabilità. I grafici non possono essere combinati e valgono per: $|M_x| \leq 0.1 |M_y|$ e $|M_x| \leq 0.1 |M_z|$.
Fatigue limit: estimated lifetime higher than 10×10^6 cycles with 99% probability. Charts cannot be combined and are valid for: $|M_x| \leq 0.1 |M_y|$ and $|M_x| \leq 0.1 |M_z|$.

--- Arresto d'emergenza max 100 volte nel corso della vita del prodotto.
Emergency stop max 100 times during service life.

Per casi di sollecitazione composta si faccia riferimento all'ufficio tecnico.
In case of combined stress contact our technical department.

MODELLO / MODEL
VER090FM

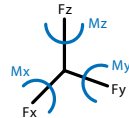

Sono rappresentate le deformazioni massime in condizioni isostatiche, con vincolo rigido e carico all'estremità. La deformazione effettiva dipende dalle condizioni di vincolo e dalla combinazione di carico.
Maximum deflection in an isostatic cantilever loaded condition. Actual strain depends on constraint condition and load combination.

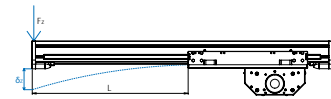

DEFORMAZIONE ELASTICA / ELASTIC DEFORMATION

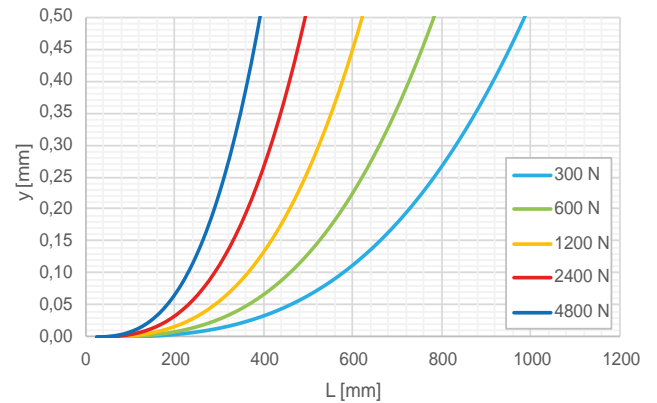
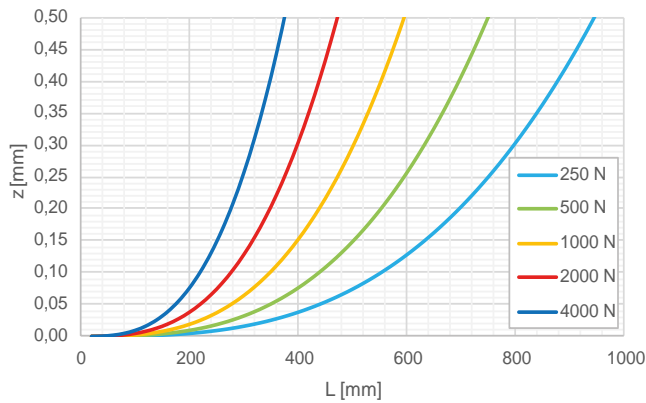

LIMITI STRUTTURALI / STRUCTURAL LIMITS

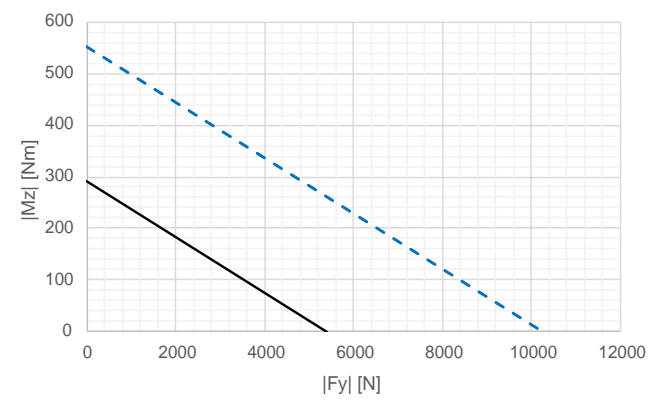
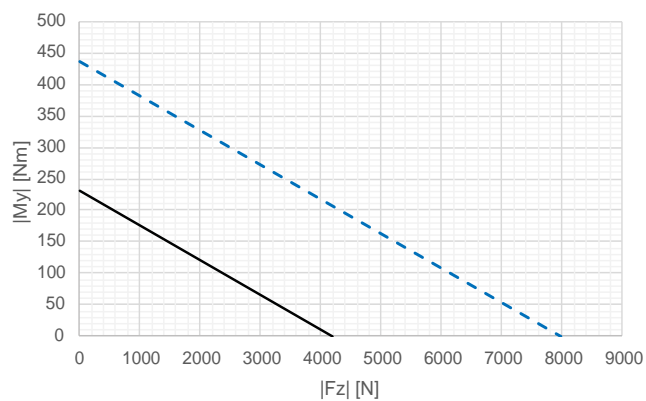

— Limite rottura a fatica: vita stimata superiore ai 10×10^6 cicli col 99% probabilità. I grafici non possono essere combinati e valgono per: $|M_x| \leq 0.1 |M_y|$ e $|M_x| \leq 0.1 |M_z|$.
Fatigue limit: estimated lifetime higher than 10×10^6 cycles with 99% probability. Charts cannot be combined and are valid for: $|M_x| \leq 0.1 |M_y|$ and $|M_x| \leq 0.1 |M_z|$.

--- Arresto d'emergenza max 100 volte nel corso della vita del prodotto.
Emergency stop max 100 times during service life.

Per casi di sollecitazione composta si faccia riferimento all'ufficio tecnico.
In case of combined stress contact our technical department.